

MECAMAM

M

SISTEMAS DE PIC-KING ATOX

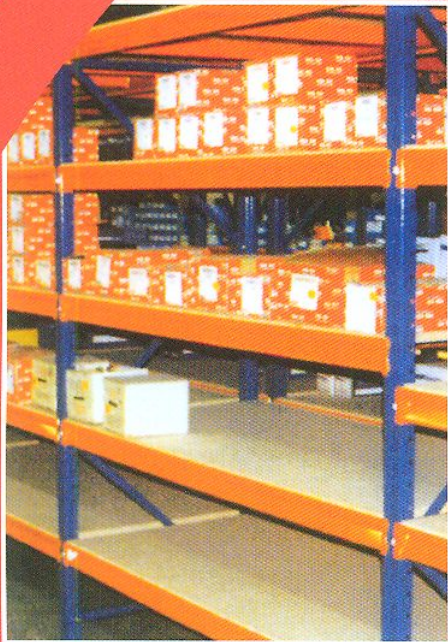

TEL 96 379 88 35
FAX 96 370 76 48

INDUSTRIAS MAM,S.A
FÁBRICA Y OFICINAS

POLÍGONO INDUSTRIAL VIRGEN DE LA SALUD, PARCELA 16
APDO. 83 - 46950 - CHIRIVELLA (VALENCIA) - (ESPAÑA)
E.mail: mecamam@mecamam.com - WEB: <http://www.mecamam.com>

MECAMAM

M

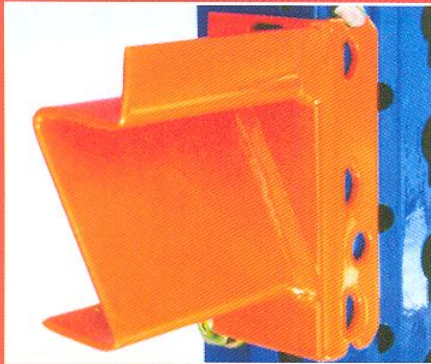

Larguero de perfil "Z"



Pie metálico

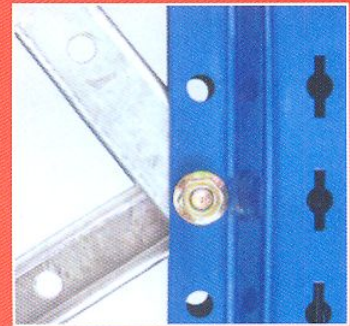

Bastidor atornillado

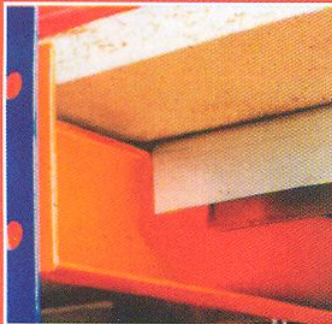

Travesaño de apoyo

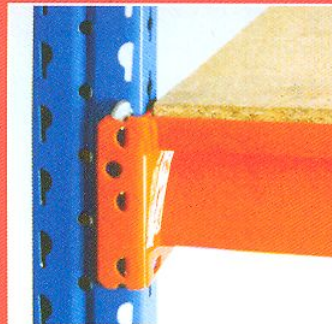

Panel aglomerado



Panel metálico

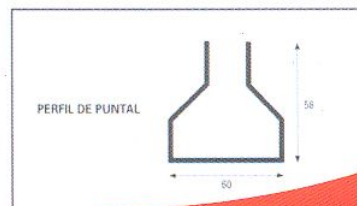
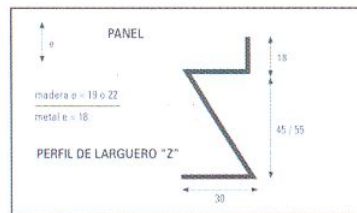
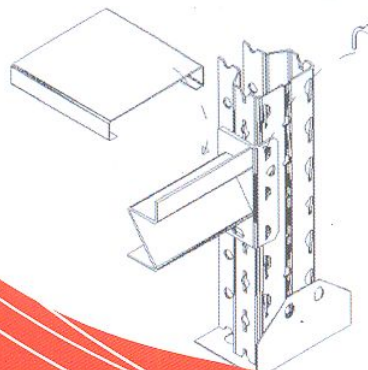

DELEGACIONES

MADRID: C/ NARCISO SERRA, Nº21 - CP 28007 - TEL 91 552 43 27 - FAX 91 552 43 27

VALENCIA: APARTADO 83 - CHIRIVELLA - CP 46950 - TEL 96 379 8835 - FAX 96 370 76 48

BARCELONA: CTRA. MOLINS DE REI A RUBÍ, KM 8'7 - RUBÍ - CP 08191 - TEL 93 699 12 11 - FAX 93 588 01 85